



- Sturdy: entirely made of brass;
- Quick and easy installation: can be assembled in a few seconds;
- **Universal:** compatible with the whole range of *SafeCleaner2* and *Mag-Nus* filters and *Airterm UP* deaerators.

PRODUCTION RANGE

Code	Size
2343.05.00	Universal

DESCRIPTION

The RBM connector for cleaning/washing system is compatible with all components equipped with adjustable diverter, specifically dirt separators filters model *SafeCleaner2* (2405 - 2344 - 2319 series) and *Mag-Nus* (2098 series) and deaerators model *Airterm UP* (2649 series).

It is an easy-to-use connection tool, enables you to simplify and speed up the washing operation of a heating system. Thanks to the RBM connector there is no need to disassemble the circulator or fix the connections to radiators or other access points of the system; simply unscrew the filter or deaerator body, screw the connector to the switch already installed on the system and everything is ready for flushing operations.

For the operations to perform, refer to paragraph "*Instructions for connector application to filter and system washing*" of this technical sheet.

CONSTRUCTION FEATURES

- Body: Nickel-plated brass
- Seals: EPDM PEROX

TECHNICAL FEATURES

- Max operating pressure: 10 Bar
- Max operating temperature: 130 °C

OVERALL DIMENSIONS

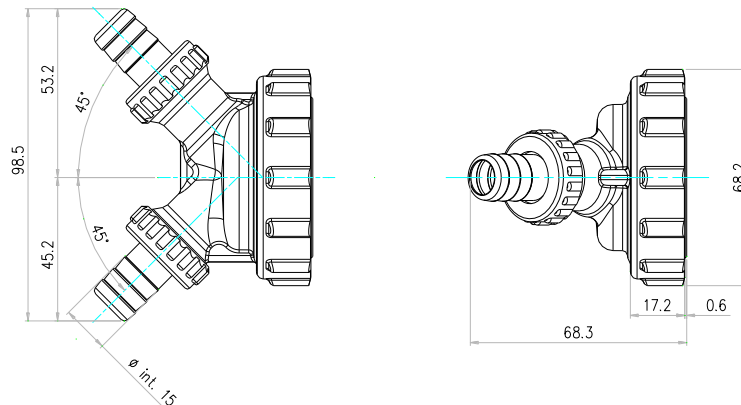





All sizes must be considered in mm.

INSTRUCTIONS FOR CONNECTOR APPLICATION TO FILTER AND SYSTEM WASHING

These instructions explain how to install the connector and how to wash the system. Read them carefully before commencing the installation or maintaining the product.

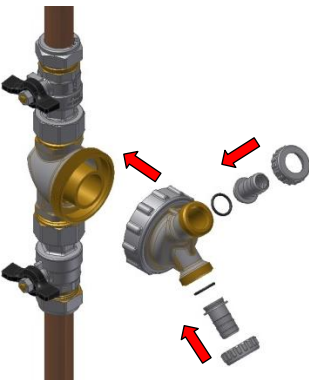
WARNINGS: Ensure the working environment is safe. RBM recommends that the boiler is off and the system is allowed to cool at a room temperature before carrying out any maintenance intervention, in order to avoid burns.

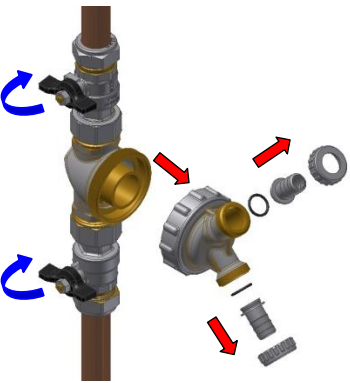
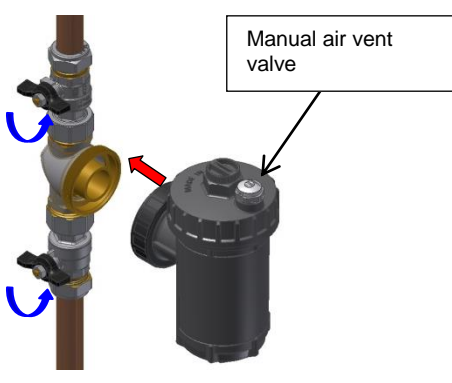
	
1 - Intercept the filter by closing the ball valves.	2 - Remove the main body of the filter from the diverter.
	
3 - Install the connector on the diverter body, pay attention that the O.R. is correctly positioned in its housing, in order to ensure perfect hydraulic tightness.	4 - Connect the pipes to the two hose connections of the connector, open the ball valves restarting the system and perform the flushing.
	
5 - Once finished the system washing operations, intercept the system and remove the connector.	6 - Reassemble the main body of the filter on the diverter, make sure that the O.R. is correctly positioned in its housing, in order to ensure perfect hydraulic tightness. Open the ball valves restarting the system. Release the air in the system through the air vent valve on the filter.



RBM spa reserves the right to improve and change the described products and related technical data at any moment and without prior notice: always refer to the instructions attached with the supplied components; this sheet is an aid, should the instructions be extremely schematic. Our technical department is always at your disposal for any doubt, problem or clarification.

RBM Spa
 Via S. Giuseppe, 1
 25075 Nave (Brescia) Italy
 Tel. 030-2537211 Fax 030-2531798
 E-mail: info@rbm.eu - www.rbm.eu